

CE

# BOTTLED WATER DISPENSING SYSTEM

## INSTALLATION & MAINTENANCE INSTRUCTIONS

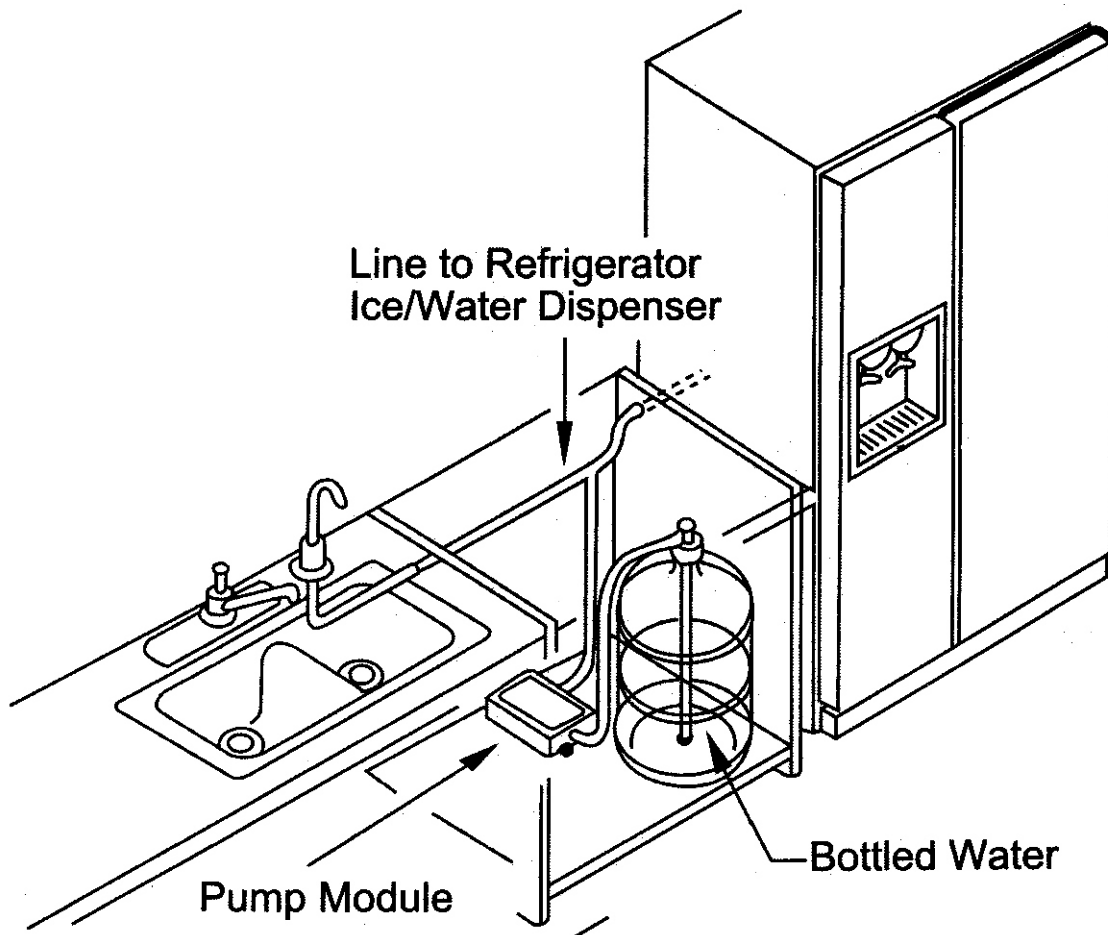

## HOW THE SYSTEM WORKS

The **Bottled Water Dispensing System** was designed to pump water from a commercially available 5-gallon water bottle. The system will deliver the water under pressure to an individual drinking water faucet, the water inlet of a refrigerator to the icemaker and chilled drinking water tap, and to certain commercial coffee / tea brewers.

When the suction wand is inserted into the 5-gallon bottle, it will activate the float switch on the end of the wand and turn on the pump. This same float switch shuts off the system when the bottle is empty. The wand has a built in back-flow preventor valve that prevents water in the system from flowing back into the bottle, or spilling while changing bottles.

The heart of the system is the pump module that automatically adjusts the flow and pressure to fill an appliance or faucet, and stops automatically.

---

## INVENTORY OF SYSTEM COMPONENTS

- A. Suction Wand and Hose Assembly
- B. Pump Module with On/Off Rocker Switch, 6 Ft. Cord
- C. 20 feet of 1/4 inch Discharge Tube
- D. Optional Refrigerator Fitting.

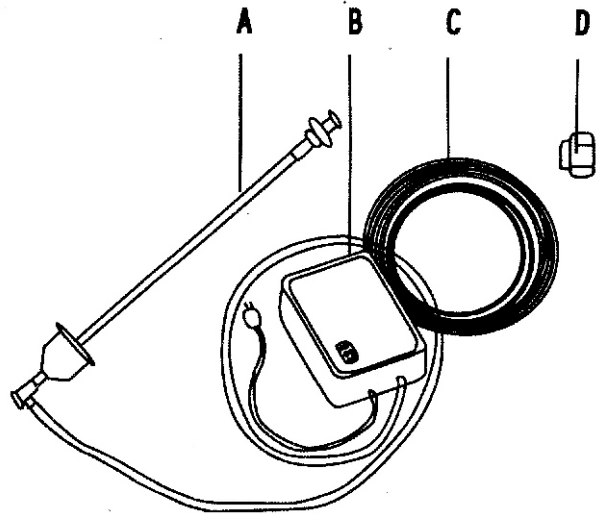

## TOOLS REQUIRED TO INSTALL SYSTEM

- 1. Medium sized Wrench
- 2. 7/16" or 1/2" Drill Bit
- 3. Power Drill
- 4. Sharp Knife or Box Knife

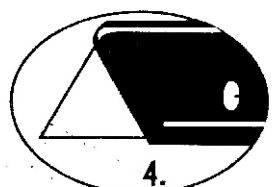
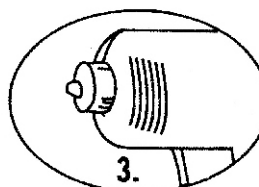
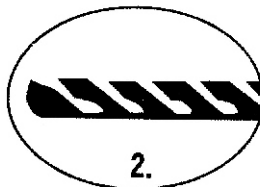
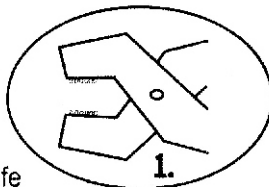

## MOUNTING OF SYSTEM

Select a cabinet large enough to accommodate the 5 gallon bottle and suction wand assembly. Place the Pump Module on the floor of the cabinet with on/off switch and suction tube facing out toward the cabinet doors. Position as close as possible to a grounded electrical outlet and place the five gallon bottle close to the Pump Module without kinking the suction hose.

The Bottled Water Dispensing System may also be placed in a pantry, closet, cellar or other location where a grounded electrical outlet is available.

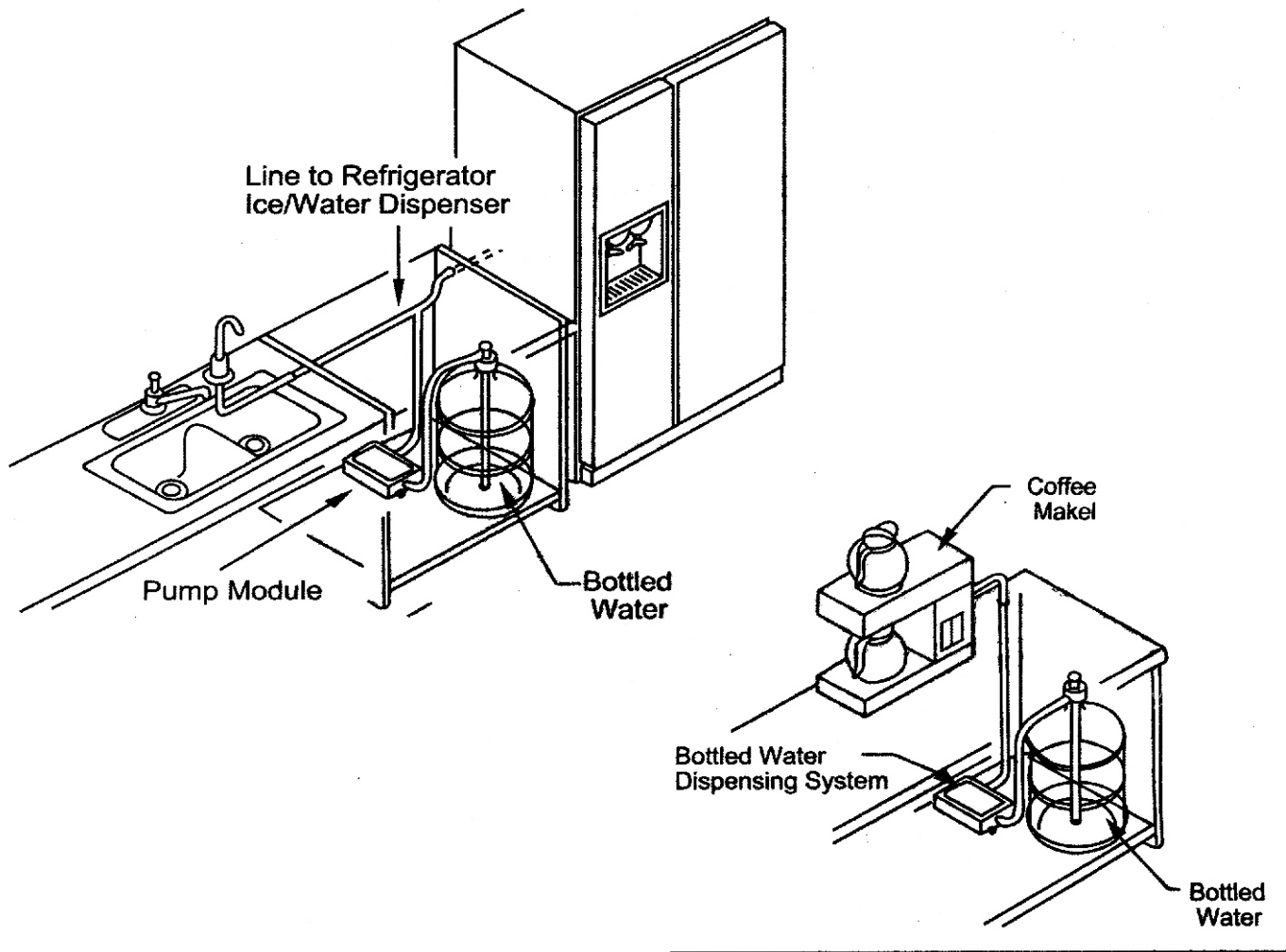

## **REMOVAL OF PLUG**

To remove plug (red or white in color):

1. Push in collet squarely against face of fitting
2. With the collet held in this position, the plug can be removed.

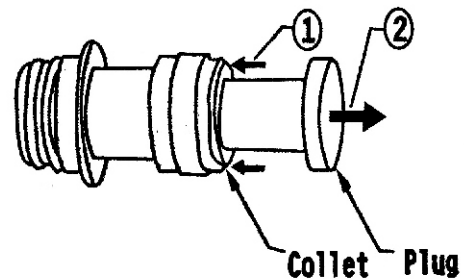

## PLUMBING

There is 20 feet of 1/4" O.D. polyethylene tubing supplied with the Bottled Water Dispensing System. Carefully measure the distance between the pump module outlet and the appliance water inlet or optional faucet, and cut the tubing clean and square to prevent fitting leaks. If the refrigerator and optional faucet are being connected, use the 1/4" tube "T" fitting and place it in an accessible location. Remove the plug from the pump module outlet port by pushing the collet against the body while sliding the plug out of the fitting. See removal of plugs (Page 2). Push the cleanly cut tubing end into the pump module outlet port, past the o-ring to tube stop. Route tubing to the refrigerator water valve and connect it to the water inlet valve in the back of the refrigerator by using the tube connector fitting. First slip nut over the tube, then place the ferrule over the tube, then install onto the refrigerator water valve fitting and tighten.

For installation and use with commercial coffee and tea brewing equipment: Many commercial coffee and tea brewing machines can be connected to a water supply line. Ensure that you have a 1/4" I.D. connection fitting at the water inlet that can accept the supplied 1/4" O.D. tubing. These brewing machines have a factory installed device that restricts incoming water to a safe pressure that won't damage the brewing machine. This device is usually referred to as an inlet pressure regulator or flow restrictor, and limits incoming water pressure to approx. 90-100 psi. If you intend to use the system with one of these brewing machines, you should remove the brewing machine's inlet restrictor device. Consult the brewing machine manufacturer for details. Failure to remove the brewing machine's restrictor may cause the series pump to cycle itself off and on repeatedly, leading to premature motor failure of the unit. This type of failure is not covered under warranty. Use of filter devices with your commercial brewer is unnecessary; see below.

For installation on refrigerators with ice making and/or water dispensing functions: Do not use any external filtration devices. These will cause the pump to over-cycle, possibly causing premature pump failure, not covered under warranty. If your refrigerator has factory installed internal filtration that must remain in place as part of the water line, this too may cause over-cycling resulting in pump failure. Contact the refrigerator maker and inquire about obtaining an empty or dummy filter housing for use instead of the standard filter model. If none is available, the use of a small accumulator tank will be necessary.

---

## ELECTRICAL

### **WARNING: Risk of Electrical Shock!**

Certain CBW models are available without an electrical plug; this allows for direct connection to the power source, or the addition of a particular plug type not available from . Additionally, it may become necessary to replace a damaged plug. Observe these instructions when connecting your CBW unit to a plug or power source.

**PRESSURE WARNING:** Maximum total head is 28m when pump switch cutoff occurs.

Make sure the power source conforms to the pump voltage.

Be sure that all power is disconnected before connecting the CBW unit to the power source.

For 115V AC models with plugs: Plug the power cord into a grounded outlet after moving pump system's rocker switch to OFF position.

For 115V AC models without plugs: Black wire lead is common, White wire lead is neutral, and Green/Yellow wire lead is ground. If adding plug, plug into grounded outlet after moving pump system's rocker switch to OFF position.

For 230V AC models with plugs: Plug the power cord into a grounded outlet after moving pump system's rocker switch to OFF position. Make sure supplied plug matches outlet configuration.

For 230V AC models without plugs: Brown wire lead is live, Blue wire lead is neutral, and Green/Yellow wire lead is ground. If adding plug, plug into grounded outlet after moving pump system's rocker switch to OFF position.

**WARNING:** Never connect the Green/Yellow wire lead to a common or live terminal!

For 12V DC models: Connect the Red wire lead (positive/+) to a minimum 4 amp circuit and connect the Black wire lead (negative/-) to the battery ground or chassis. For runs to 20 feet use 18 or 16 AWG; for runs to 50 feet, use 16 or 14 AWG.

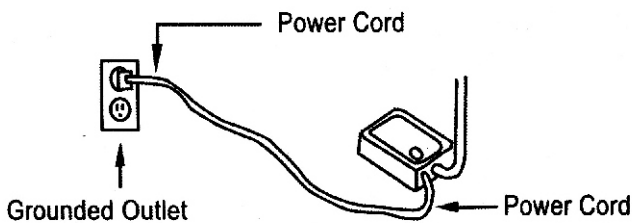

**WARNING!**  
 Damaged power cord  
 must be replaced by  
 factory authorized  
 service only!

### SYSTEM START-UP

Before the Bottled Water Dispensing System is put into service, the system should be sanitized by following the maintenance and sanitation clean in-place procedure on page five (5).

After the Bottled Water Dispensing System has been mounted in a suitable location with the suction wand installed into the bottle and the discharge tube routed to the appliance water inlet (or to the optional drinking water faucet), the 115 volt AC and 230 volt AC systems must be plugged into a grounded outlet, and the 12 volt DC system must be hard wired to the vehicle or boat electrical system as outlined in the electrical section.

Turn the dispensing system on by placing the on/off switch in the on position and operating the appliance dispensing valve or the drinking water faucet to vent all the air from the Bottled Water Dispensing System. After air is evacuated from the system, close the appliance dispensing valve or the water faucet and the pump will stop automatically until you open the water dispenser valve or water faucet. Follow manufacturer's plumbing and operating instructions with commercial coffee and tea brewers.

For refrigerators with icemaker only, the seal at the icemaker connection should be loosened or disconnected to vent the trapped air in the system. When water is present at the connection, reconnect, tighten and check for leaks.

Once the system is vented, it will not require venting again even after bottle changes.

### SUCTION WAND INSTALLATION

To install the suction wand into standard 5 gallon bottle, place bottle close to system and remove bottle cap, then install suction wand into bottle. (Note: If bottle is over filled), dispense enough water to allow the suction wand to be installed to the bottom of the bottle). Push suction wand bottle cap over bottle and push wand to bottom center of bottle.

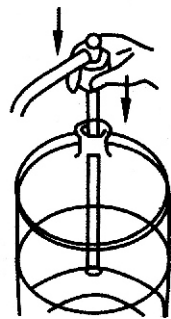

### SUCTION WAND REMOVAL AND CHANGING BOTTLES

Before removing suction wand from empty bottle, move bottle to an open area outside of cabinet. Put new bottle next to empty bottle, clean neck and cap area with detergent, and remove cap. Remove suction wand from empty bottle by lifting wand cap with a rocking motion and pull cap off bottle, sliding suction wand out of the bottle and place directly into new bottle while sliding cap over new bottle neck.

Do not attempt to remove suction wand by pulling on the soft plastic tube, which can result in permanent breakage of suction wand.

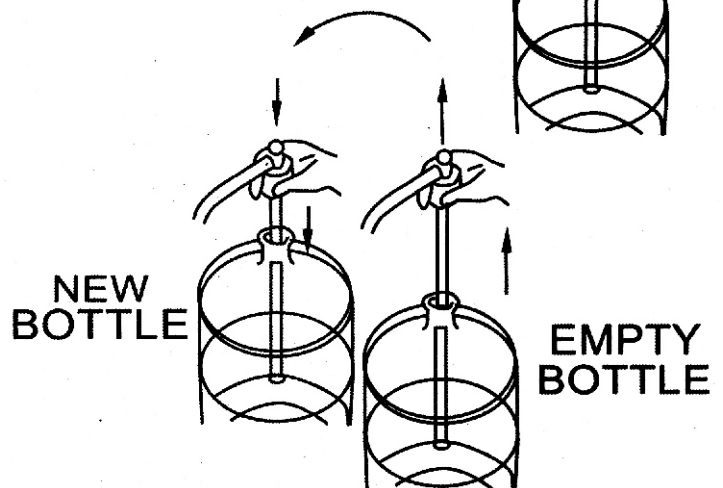

Do not place suction wand on floor, counter, or sink as this could contaminate the suction wand assembly. If bottle is over filled, dispense enough water to allow the suction wand to be pushed to bottom of bottle.

## MAINTENANCE AND SANITATION

### Equipment Required

- Two (2) 2 1/2 Gallon Household Pails
- One (1) Roll of Paper Towels
- One (1) Small Container of Household Bleach

### Clean In-Place Procedure

Using the on/off switch on the front of the enclosure, turn Bottled Water Dispensing System off by putting the switch in the off position

Fill a clean pail (A) with two (2) gallons of hot tap water (135°F/57.2°C), adding one (1) ounce of household bleach.

Remove the suction wand from the pure water bottle and submerge the bottle cap end into pail (A), taking care to ensure that the metal hose clamp connecting the hose to the suction wand is totally immersed in the water/bleach solution, for ten minutes and then wash underside of cap and suction tube exterior with a clean paper towel. If using the optional faucet, disconnect the tubing.

Remove the faucet, immersing it in the water/bleach solution for ten minutes. Wash the faucet exterior with clean paper towel; install the faucet and reconnect the tubing. Place suction wand into clean empty pail (B) and dispose of solution in pail (A).

Refill the cleaned pail (A) with two (2) gallons of hot tap water (135°F/57.2°C) adding one (1) ounce of household bleach and place suction wand into pail with bottle cap up.

Disconnect the discharge tube from the faucet or the refrigerator and place into the empty second pail (B). (Do not use pail with clean water and chlorine solution):

Turn dispensing system on, by placing on/off switch in the on position and dispense all of the chlorine solution into pail (B). Place discharge tube into pail (A) and dispose of bleach, and rinse pail (B). Replace tube into pail (B).

Refill pail (A) with two (2) gallons of hot tap water (135°F/57.2°C), adding one (1) ounce of household bleach. Dispense bleach as in step #6.

Reinstall suction wand into new bottle of pure water and reconnect discharge tube into refrigerator or faucet and dispense 12 to 18 ounces of water, or until bleach taste is removed.

Cleaning should be performed at least four (4) times per year.

### CAUTION

Do not place Bottled Water Dispensing System into a dishwasher as it will cause electrical failure of pump and controls.

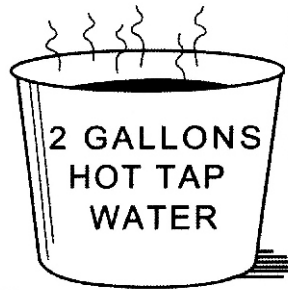

**CAUTION!**  
135°F (57.2°C)  
Maximum Water  
Temperature

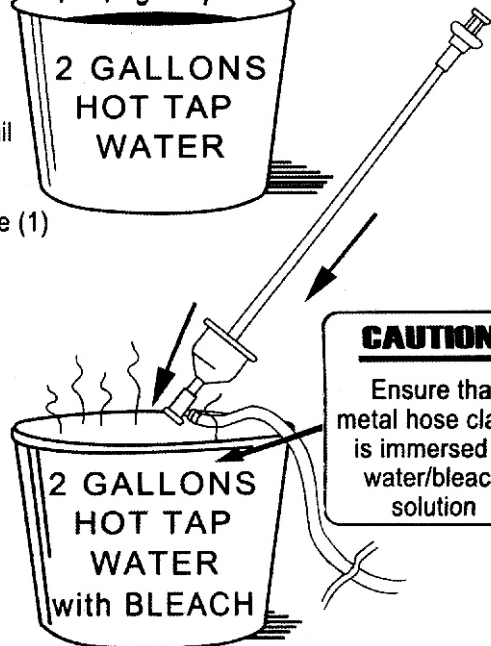
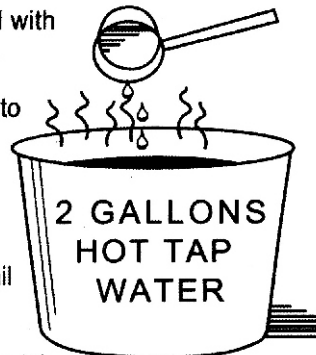
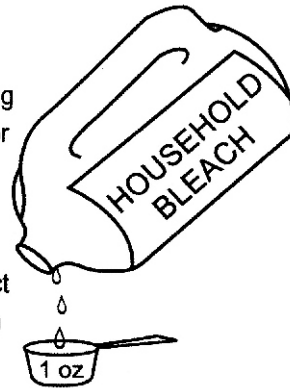

**CAUTION!**  
Ensure that  
metal hose clamp  
is immersed in  
water/bleach  
solution

## **TROUBLESHOOTING**

### **System Will Not Dispense Water**

- Check on/off switch position
- Check power to dispensing system
- Check location of suction wand in bottle
- Check for empty bottle
- Check for air in system

### **Discharge Tube Leaks At Fitting**

- Push tube all the way into tube stop
- Remove tube and cut 1/4" off end, square and reinstall
- Check correct tube size in fitting, tube size is 1/4" O.D. Fitting should be 1/4" I.D.

### **System will Not Shut-Off**

- Check for leaks in tubing system
- Check for leaks at tube fittings
- Check for leaks at faucet, ice maker or refrigerator water valve
- check pressure switch by turning faucet off and on
- Check float switch position in bottle

### **System continually turns off and on while in use**

- Check for restriction device at appliance inlet.
- Check for filter unit in line.